

Aida Lounge

Manufacturer: Cierre1972 Italy

aida A

design_Stefano Conicconi

description

modular sofa with a metal frame supported by elastic belts. The armrests are made of wood and expanded polyurethane foam covered with sterilized hypoallergenic goose-down. The seat and back cushions are made of expanded polyurethane foam covered with sterilized hypoallergenic goose-down. The legs are made of black chrome-plated metal available also in polished chrome. The tables are made of metal covered with acrylic fibre.

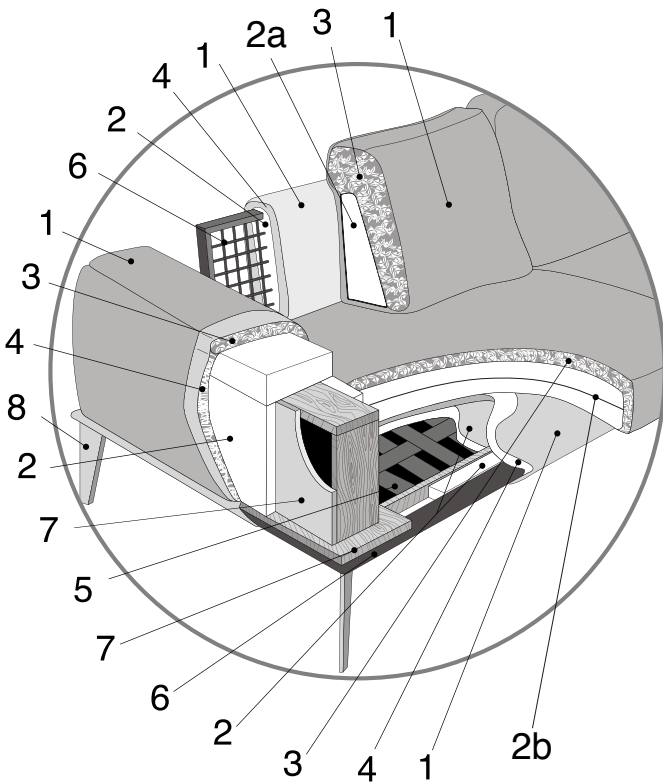

materials

1. cover
2. frame upholstered with expanded ethane foam in different densities from 30 to 110 kg/m³: 4 types of foa
- 2.a. back cushions upholstery is in polyurethane foam with a density of 25 kg/m³
- 2.b. seat cushions upholstery is in polyurethane foam with a density of 35em and at35 kg/m³: 2 types of foams
3. sterilized hypoallergenic
4. acrylic padding
5. elastic belts
6. metal frame
7. frame in multilayer poplar
8. black chrome-plated or polished chrome-plated metal leg

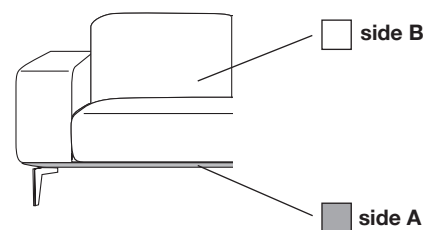
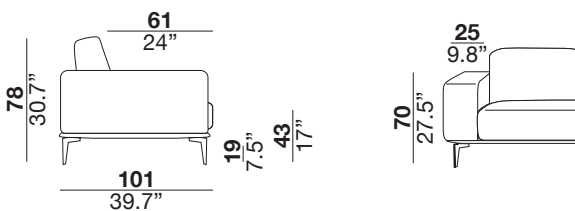

PRICE CALCULATION IN TWO MATERIALS: to calculate the total price of a unit in two materials, please sum the prices of the two columns: A + B

Aida Lounge

Manufacturer: Cierre1972 Italy

2_2 seats sofa

kg 79_volume 1,71 m³

	single material	two materials	
		A	B
C.O.L. / C.O.M.	\$12,141	-	-
cat. 0	\$12,859	\$762	\$12,482
cat. 1	\$14,286	\$844	\$13,868
cat. 2	\$15,518	\$1,086	\$14,897

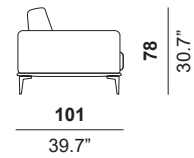
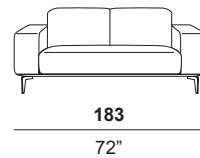

I_2,5 seats sofa

kg 85_volume 1,79 m³

	single material	two materials	
		A	B
C.O.L. / C.O.M.	\$12,837	-	-
cat. 0	\$13,591	\$762	\$13,233
cat. 1	\$15,100	\$844	\$14,707
cat. 2	\$16,332	\$1,086	\$15,738

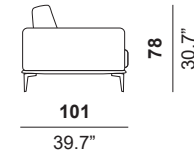
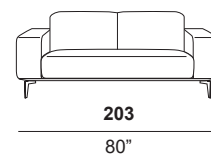

3_3 seats sofa

kg 97_volume 1,79 m³

	single material	two materials	
		A	B
C.O.L. / C.O.M.	\$13,500	-	-
cat. 0	\$14,289	\$762	\$13,959
cat. 1	\$15,879	\$844	\$15,507
cat. 2	\$17,144	\$1,086	\$16,572

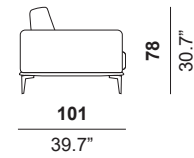
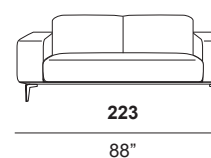

X_maxi sofa

kg 107_volume 2,13 m³

	single material	two materials	
		A	B
C.O.L. / C.O.M.	\$14,223	-	-
cat. 0	\$15,059	\$762	\$14,751
cat. 1	\$16,728	\$844	\$16,387
cat. 2	\$18,120	\$1,086	\$17,578

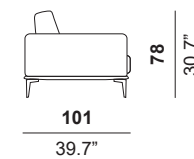
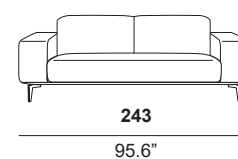

standard leg: black chrome-plated

PRICE CALCULATION IN TWO MATERIALS: to calculate the total price of a unit in two materials, please sum the prices of the two columns: A + B

Aida Lounge

Manufacturer: Cierre1972 Italy

40_90° corner piece

kg 55_volume 0,95 m³

	single material	two materials	
		A	B
C.O.L. / C.O.M.	\$9,721	-	-
cat. 0	\$10,288	\$399	\$10,200
cat. 1	\$11,432	\$440	\$11,330
cat. 2	\$11,842	\$611	\$11,589

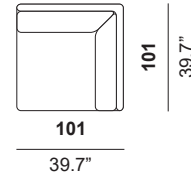

04_round corner piece

kg 80_volume 2,56 m³

	single material	two materials	
		A	B
C.O.L. / C.O.M.	\$10,409	-	-
cat. 0	\$11,022	\$399	\$10,953
cat. 1	\$12,246	\$440	\$12,174
cat. 2	\$13,266	\$611	\$13,057

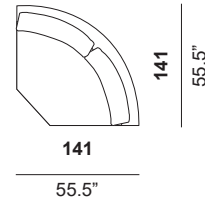

07P_small 2 seats let arm | 08P_small 2 seats right arm

kg 70_volume 1,71 m³

	single material	two materials	
		A	B
C.O.L. / C.O.M.	\$11,281	-	-
cat. 0	\$11,949	\$399	\$11,910
cat. 1	\$13,277	\$440	\$13,233
cat. 2	\$14,286	\$611	\$14,105

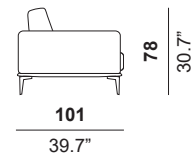
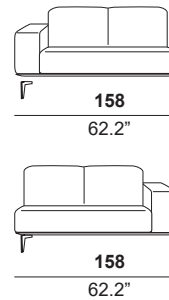

07_2 seats left arm | 08_2 seats right arm

kg 75_volume 1,71 m³

	single material	two materials	
		A	B
C.O.L. / C.O.M.	\$11,979	-	-
cat. 0	\$12,680	\$762	\$12,298
cat. 1	\$14,088	\$844	\$13,665
cat. 2	\$15,100	\$1,086	\$14,465

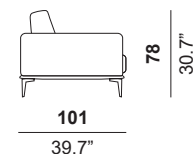
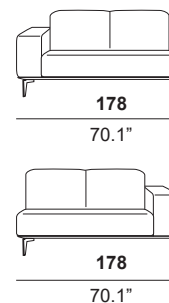

standard leg: black chrome-plated

PRICE CALCULATION IN TWO MATERIALS: to calculate the total price of a unit in two materials, please sum the prices of the two columns: A + B

Aida Lounge

Manufacturer: Cierre1972 Italy

19_3 seats (2 cushions) left arm | 20_3 seats (2cushions) right arm

kg 80_volume 1,71 m³

	single material	two materials	
		A	B
C.O.L. / C.O.M.	\$12,493	-	-
cat. 0	\$13,228	\$762	\$12,865
cat. 1	\$14,699	\$844	\$14,295
cat. 2	\$15,923	\$1,086	\$15,312

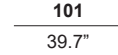
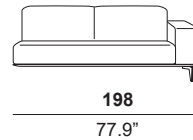
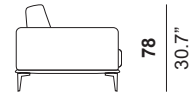
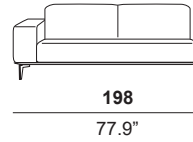

29_maxi sofa (2 cushions) left arm | 30_maxi sofa (2 cushions) right arm

kg 80_volume 1,79 m³

	single material	two materials	
		A	B
C.O.L. / C.O.M.	\$13,112	-	-
cat. 0	\$13,885	\$762	\$13,538
cat. 1	\$15,428	\$844	\$15,045
cat. 2	\$16,698	\$1,086	\$16,110

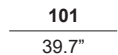
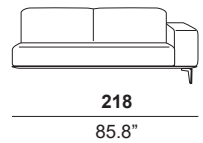
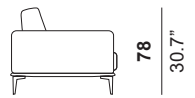
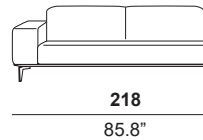

37_meridienne lounge left | 38_meridienne lounge right

kg 97_volume 2,13 m³

	single material	two materials	
		A	B
C.O.L. / C.O.M.	\$13,354	-	-
cat. 0	\$14,143	\$762	\$13,808
cat. 1	\$15,714	\$844	\$15,342
cat. 2	\$16,880	\$1,086	\$16,297

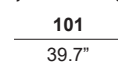
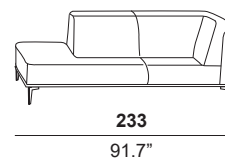
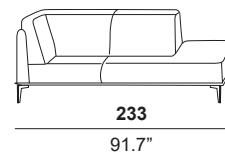

PRT_rectangular ottoman

kg 25_volume 0,44 m³

	single material	two materials	
		A	B
C.O.L. / C.O.M.	\$5,195	-	-
cat. 0	\$5,500	\$399	\$5,264
cat. 1	\$6,111	\$440	\$5,852
cat. 2	\$6,465	\$611	\$6,053



standard leg: black chrome-plated

PRICE CALCULATION IN TWO MATERIALS: to calculate the total price of a unit in two materials, please sum the prices of the two columns: A + B

Aida Lounge

Manufacturer: Cierre1972 Italy

PQU_square ottoman

kg 20_volume 0,38 m³

	single material	two materials	
		A	B
C.O.L. / C.O.M.	\$4,813	-	-
cat. 0	\$5,090	\$399	\$4,846
cat. 1	\$5,654	\$440	\$5,385
cat. 2	\$5,838	\$611	\$5,404

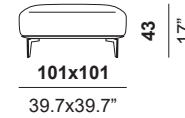

1PI_armchair

kg 50_volume 0,65 m³

	single material	two materials	
		A	B
C.O.L. / C.O.M.	\$7,249	-	-
cat. 0	\$7,684	\$399	\$7,516
cat. 1	\$8,536	\$440	\$8,349
cat. 2	\$9,248	\$611	\$8,921

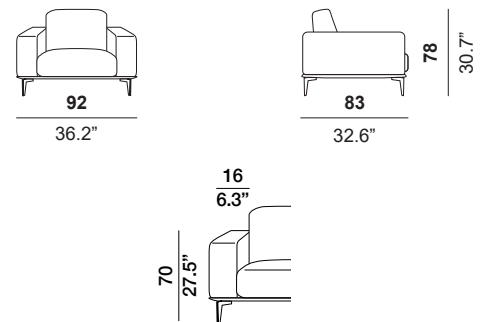

19+18

kg 155_volume 3,42 m³

	single material
C.O.L. / C.O.M.	\$24,151
cat. 0	\$25,570
cat. 1	\$28,410
cat. 2	\$30,828

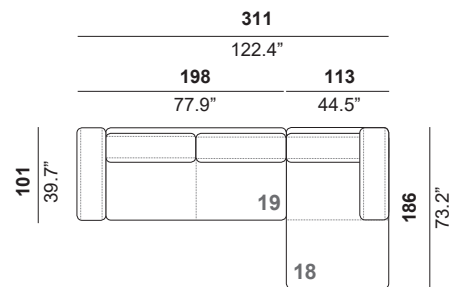

29+18

kg 155_volume 3,50 m³

	single material
C.O.L. / C.O.M.	\$24,769
cat. 0	\$26,224
cat. 1	\$29,139
cat. 2	\$31,598

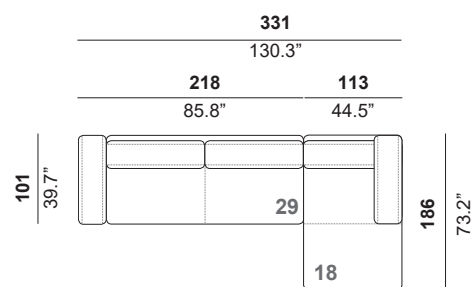

standard leg: black chrome-plated

PRICE CALCULATION IN TWO MATERIALS: to calculate the total price of a unit in two materials, please sum the prices of the two columns: A + B

Aida Lounge

Manufacturer: Cierre1972 Italy

29+37

kg 177_volume 3,92 m³

	single material
C.O.L. / C.O.M.	\$26,466
cat. 0	\$28,028
cat. 1	\$31,141
cat. 2	\$33,578

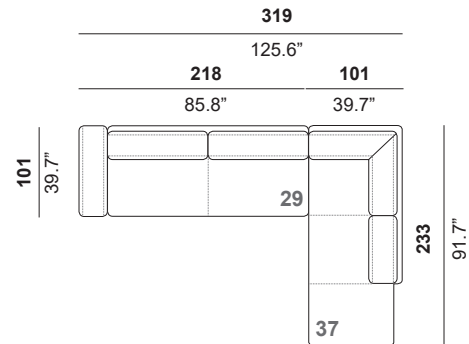

29+04+76

kg 230_volume 6,09 m³

	single material
C.O.L. / C.O.M.	\$32,890
cat. 0	\$34,826
cat. 1	\$38,693
cat. 2	\$41,797

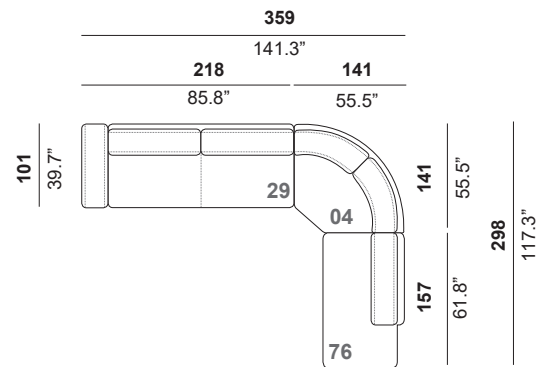

29+40+20

kg 215_volume 4,45 m³

	single material
C.O.L. / C.O.M.	\$35,327
cat. 0	\$37,400
cat. 1	\$41,555
cat. 2	\$44,459

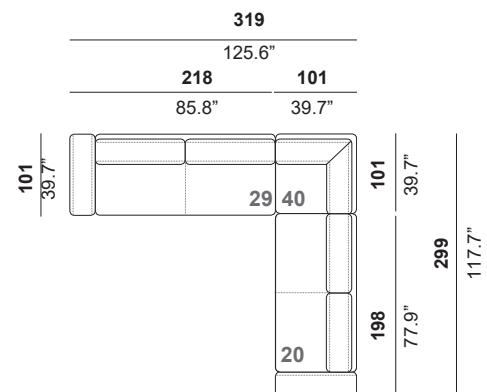

standard leg: black chrome-plated

PRICE CALCULATION IN TWO MATERIALS: to calculate the total price of a unit in two materials, please sum the prices of the two columns: A + B

Aida Lounge

Manufacturer: Cierre1972 Italy

aida small D

design_Stefano Conficconi

description

modular sofa with a metal frame supported by elastic belts. The armrests are made of wood and expanded polyurethane foam covered with sterilized hypoallergenic goose-down. The seat and back cushions are made of expanded polyurethane foam covered with sterilized hypoallergenic goose-down. The legs are made of black chrome-plated metal available also in polished chrome. The tables are made of metal covered with acrylic fibre.

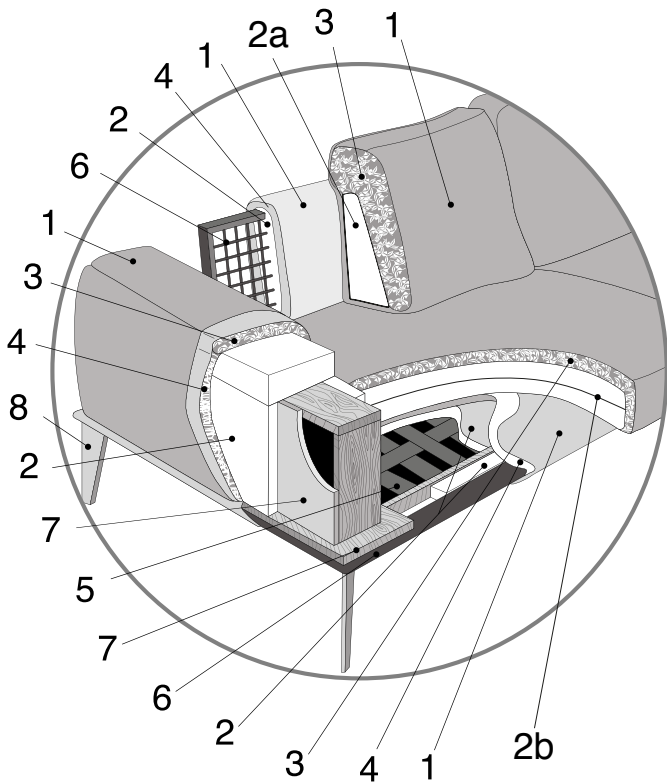

materials

- 1. cover
- 2. frame upholstered with e ethane foam in different densities from 30 to 110 kg/m³: 4 types of f
- 2.a. back cushions upholstery is in polyurethane foam with a density of 25 kg/m³
- 2.b. seat cushions upholstery is in polyurethane foam with a density of 35em and at35 kg/m³: 2 types of foams
- 3. sterilized hypoallergenic
- 4. acrylic padding
- 5. elastic belts
- 6. metal frame
- 7. frame in multilayer poplar
- 8. black chrome-plated or polished chrome-plated metal leg

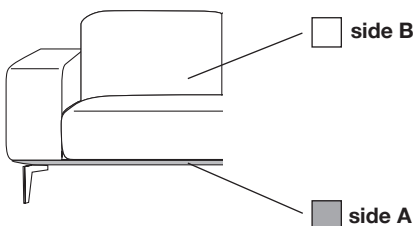

PRICE CALCULATION IN TWO MATERIALS: to calculate the total price of a unit in two materials, please sum the prices of the two columns: A + B

Aida Lounge

Manufacturer: Cierre1972 Italy

2_2 seats sofa

kg 79_volume 1,71 m³

	single material	two materials	
		A	B
C.O.L. / C.O.M.	\$12,504	-	-
cat. 0	\$13,244	\$784	\$12,859
cat. 1	\$14,715	\$872	\$14,284
cat. 2	\$15,983	\$1,117	\$15,345

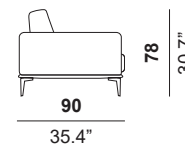
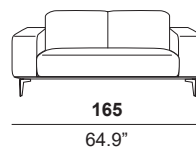

I_2,5 seats sofa

Kg 85_volume 1,79 m³

	single material	two materials	
		A	B
C.O.L. / C.O.M.	\$13,219	-	-
cat. 0	\$13,998	\$784	\$13,635
cat. 1	\$15,551	\$872	\$15,147
cat. 2	\$16,822	\$1,117	\$16,211

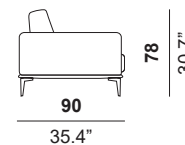
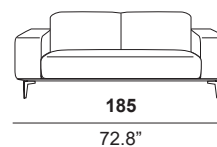

3_3 seats sofa

Kg 97_volume 1,79 m³

	single material	two materials	
		A	B
C.O.L. / C.O.M.	\$13,901	-	-
cat. 0	\$14,718	\$784	\$14,377
cat. 1	\$16,357	\$872	\$15,975
cat. 2	\$17,655	\$1,117	\$17,067

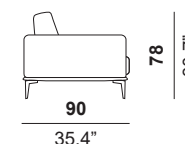
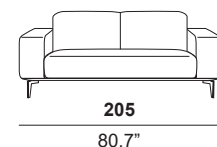

X_maxi sofa

kg 95_volume 2,13 m³

	single material	two materials	
		A	B
C.O.L. / C.O.M.	\$14,649	-	-
cat. 0	\$15,507	\$784	\$15,191
cat. 1	\$17,234	\$872	\$16,880
cat. 2	\$18,664	\$1,117	\$18,106

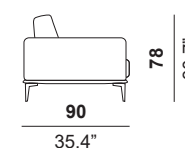
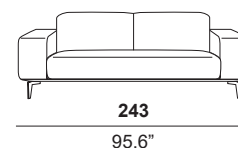

standard leg: black chrome-plated

PRICE CALCULATION IN TWO MATERIALS: to calculate the total price of a unit in two materials, please sum the prices of the two columns: A + B

Aida Lounge

Manufacturer: Cierre1972 Italy

40_90° corner piece

kg 55_volume 0,95 m³

	single material	two materials	
		A	B
C.O.L. / C.O.M.	\$10,010	-	-
cat. 0	\$10,596	\$410	\$10,505
cat. 1	\$11,773	\$451	\$11,674
cat. 2	\$12,196	\$627	\$11,938

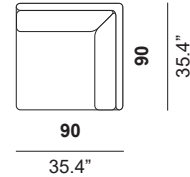

07P_small 2 seats let arm | 08P_small 2 seats right arm

kg 70_volume 1,54 m³

	single material	two materials	
		A	B
C.O.L. / C.O.M.	\$11,624	-	-
cat. 0	\$12,306	\$410	\$12,265
cat. 1	\$13,673	\$451	\$13,632
cat. 2	\$14,715	\$627	\$14,528

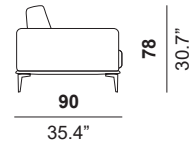
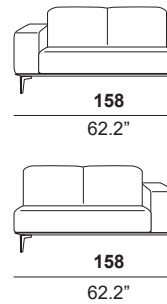

07_2 seats left arm | 08_2 seats right arm

kg 75_volume 1,71 m³

	single material	two materials	
		A	B
C.O.L. / C.O.M.	\$12,337	-	-
cat. 0	\$13,060	\$784	\$12,669
cat. 1	\$14,512	\$872	\$14,077
cat. 2	\$15,551	\$1,117	\$14,900

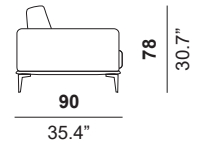
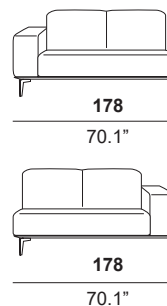

standard leg: black chrome-plated

PRICE CALCULATION IN TWO MATERIALS: to calculate the total price of a unit in two materials, please sum the prices of the two columns: A + B

Aida Lounge

Manufacturer: Cierre1972 Italy

19_3 seats (2 cushions) left arm | 20_3 seats (2cushions) right arm

kg 85_volume 1,56 m³

	single material	two materials	
		A	B
C.O.L. / C.O.M.	\$12,867	-	-
cat. 0	\$13,624	\$784	\$13,250
cat. 1	\$15,139	\$872	\$14,724
cat. 2	\$16,401	\$1,117	\$15,774

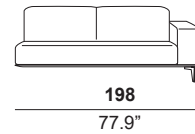
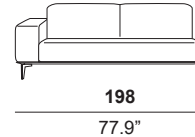

29_maxi sofa (2 cushions) left arm | 30_maxi sofa (2 cushions) right arm

Kg 80_volume 1,71 m³

	single material	two materials	
		A	B
C.O.L. / C.O.M.	\$13,505	-	-
cat. 0	\$14,300	\$784	\$13,945
cat. 1	\$15,890	\$872	\$15,494
cat. 2	\$17,196	\$1,117	\$16,594

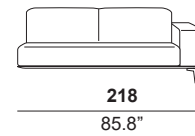
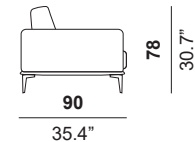
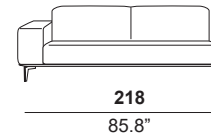

37_meridienne lounge left | 38_meridienne lounge right

kg 97_volume 2,13 m³

	single material	two materials	
		A	B
C.O.L. / C.O.M.	\$13,758	-	-
cat. 0	\$14,567	\$784	\$14,220
cat. 1	\$16,184	\$872	\$15,799
cat. 2	\$17,386	\$1,117	\$16,789

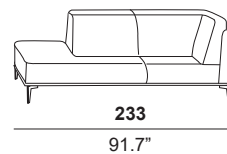
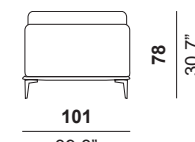
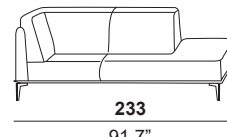

17_long-chair left arm | 18_long-chair right arm

kg 75_volume 1,71 m³

	single material	two materials	
		A	B
C.O.L. / C.O.M.	\$12,004	-	-
cat. 0	\$12,713	\$784	\$12,306
cat. 1	\$14,124	\$872	\$13,673
cat. 2	\$15,351	\$1,117	\$14,691

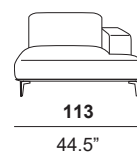
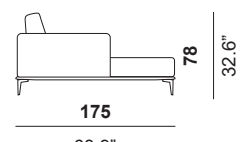
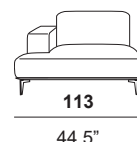

standard leg: black chrome-plated

PRICE CALCULATION IN TWO MATERIALS: to calculate the total price of a unit in two materials, please sum the prices of the two columns: A + B

Aida Lounge

Manufacturer: Cierre1972 Italy

PRT_rectangular ottoman

kg 25_volume 0,44 m³

	single material	two materials	
		A	B
C.O.L. / C.O.M.	\$5,346	-	-
cat. 0	\$5,668	\$410	\$5,426
cat. 1	\$6,295	\$451	\$6,025
cat. 2	\$6,661	\$627	\$6,232

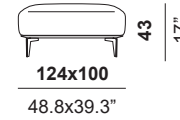

PQU_square ottoman

kg 20_volume 0,38 m³

	single material	two materials	
		A	B
C.O.L. / C.O.M.	\$4,953	-	-
cat. 0	\$5,244	\$410	\$4,994
cat. 1	\$5,825	\$451	\$5,547
cat. 2	\$6,014	\$627	\$5,569

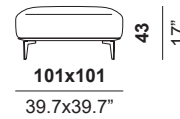

19+18

kg 155_volume 3,27 m³

	single material
C.O.L. / C.O.M.	\$24,871
cat. 0	\$26,334
cat. 1	\$29,260
cat. 2	\$31,752

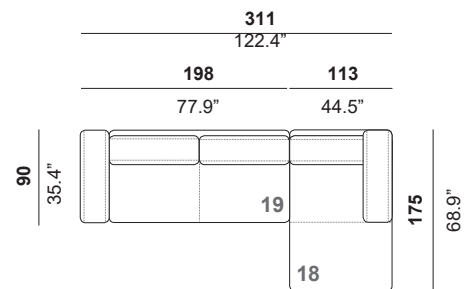

29+18

kg 150_volume 3,42 m³

	single material
C.O.L. / C.O.M.	\$25,509
cat. 0	\$27,011
cat. 1	\$30,011
cat. 2	\$32,546

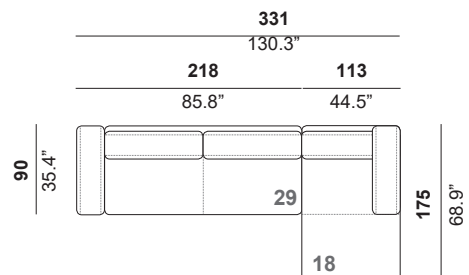

standard leg: black chrome-plated

PRICE CALCULATION IN TWO MATERIALS: to calculate the total price of a unit in two materials, please sum the prices of the two columns: A + B

Aida Lounge

Manufacturer: Cierre1972 Italy

29+37

kg 177_volume 3,84 m³

	single material
C.O.L. / C.O.M.	\$27,261
cat. 0	\$28,867
cat. 1	\$32,073
cat. 2	\$34,581

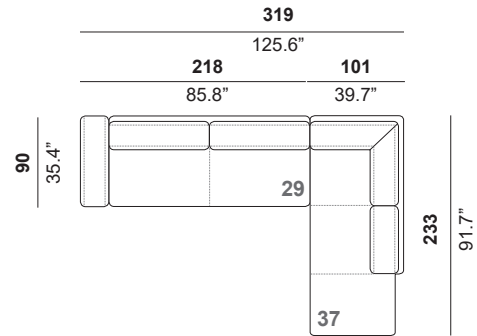

29+40+20

kg 220_volume 4,22 m³

	single material
C.O.L. / C.O.M.	\$36,380
cat. 0	\$38,519
cat. 1	\$42,801
cat. 2	\$45,793

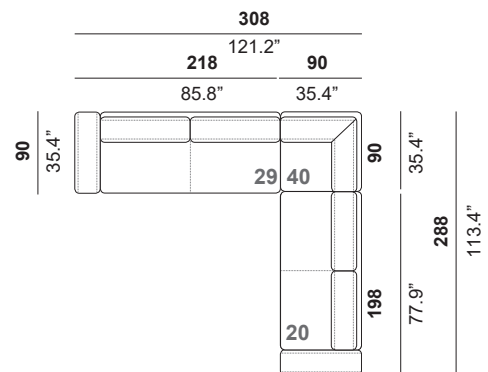

COM Orders are subject to following charges per manufacturer: \$22 per yard (any fabric) - Minimum: \$220.
COL Orders are subject to following charges per manufacturer: \$200 per leather hide.



Tusch Seating International Inc.

251 Bartley Dr. Unit #4
Toronto, ON M4A 2N7 Canada
www.tuschseating.com

T 416.368.6100
F 416.368.4477
T 888.368.6101
info@tuschseating.com